

# BEELD JE IN: GEEN RECHT OP PRIVACY

Wat zou er gebeuren als het recht op privacy plots verdwijnt? Geen privéruimte meer, zelfs niet op het toilet. Iedereen heeft toegang tot jouw berichtjes of foto's zonder jouw toestemming.

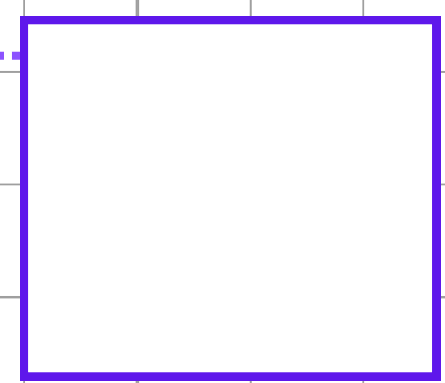
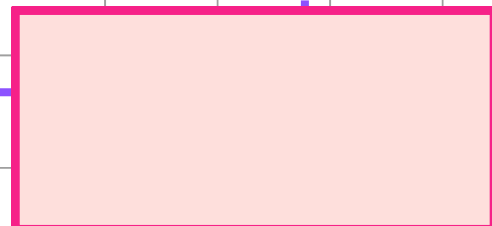
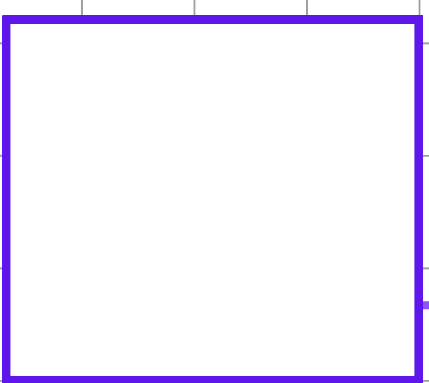
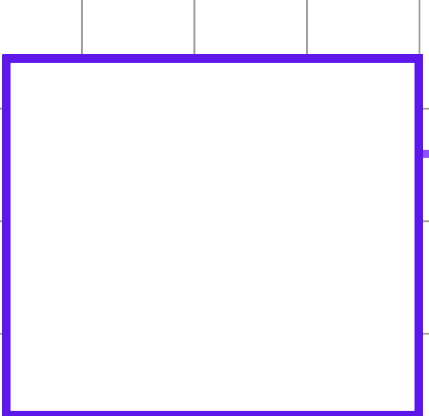
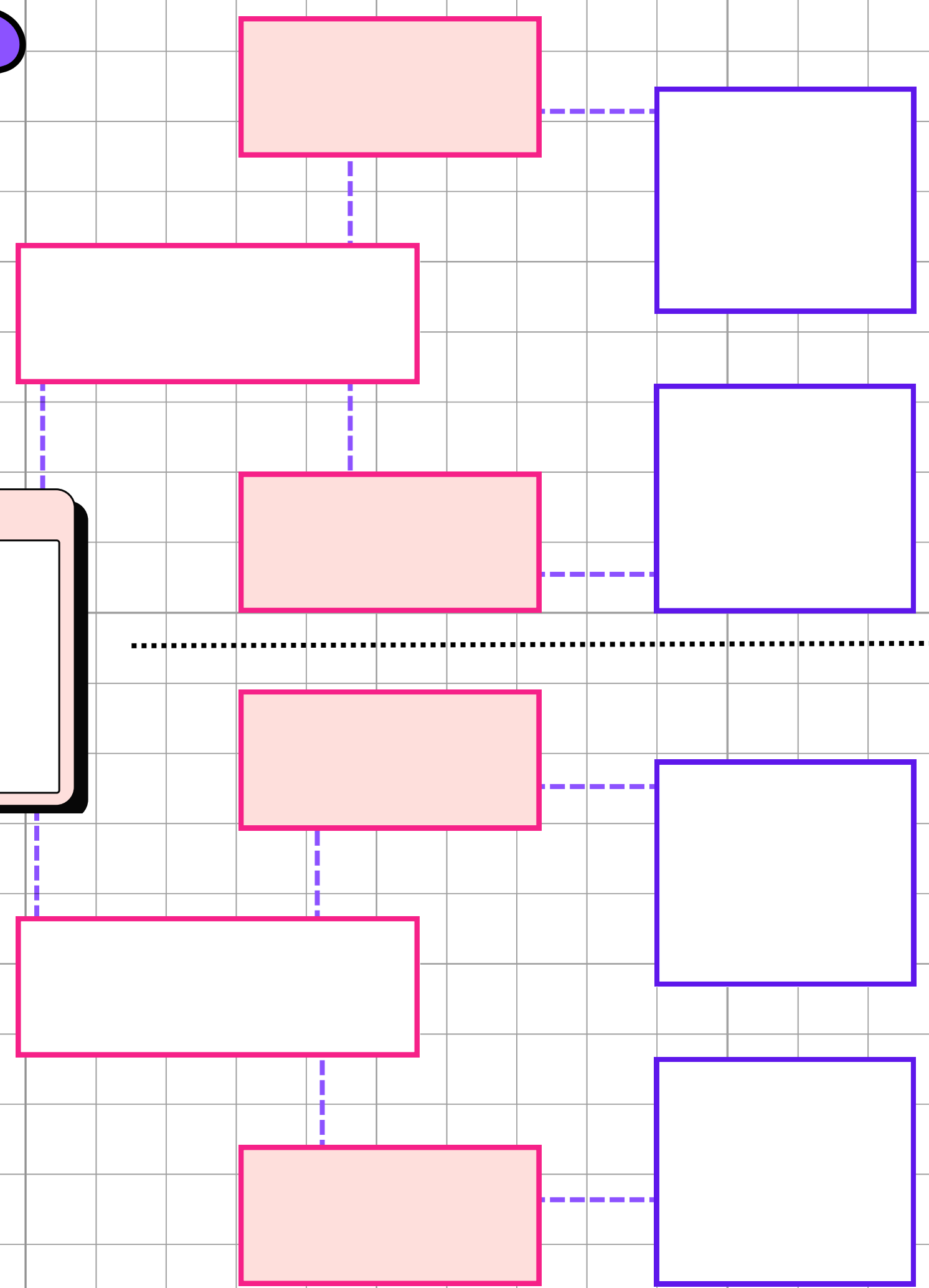
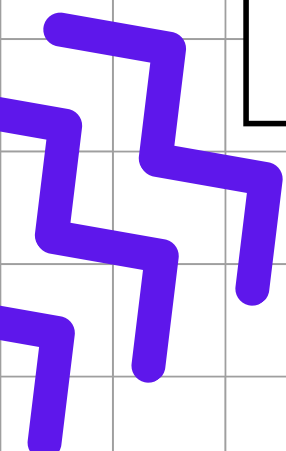
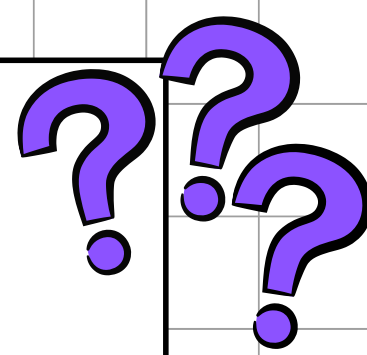

# BEELD JE IN: GEEN RECHT OP SPEL EN ONTSPANNING

Wat zou er gebeuren als het recht op spel en ontspanning plots verdwijnt? Geen speeltijden meer. Geen online plezier meer zoals gamen of chatten.

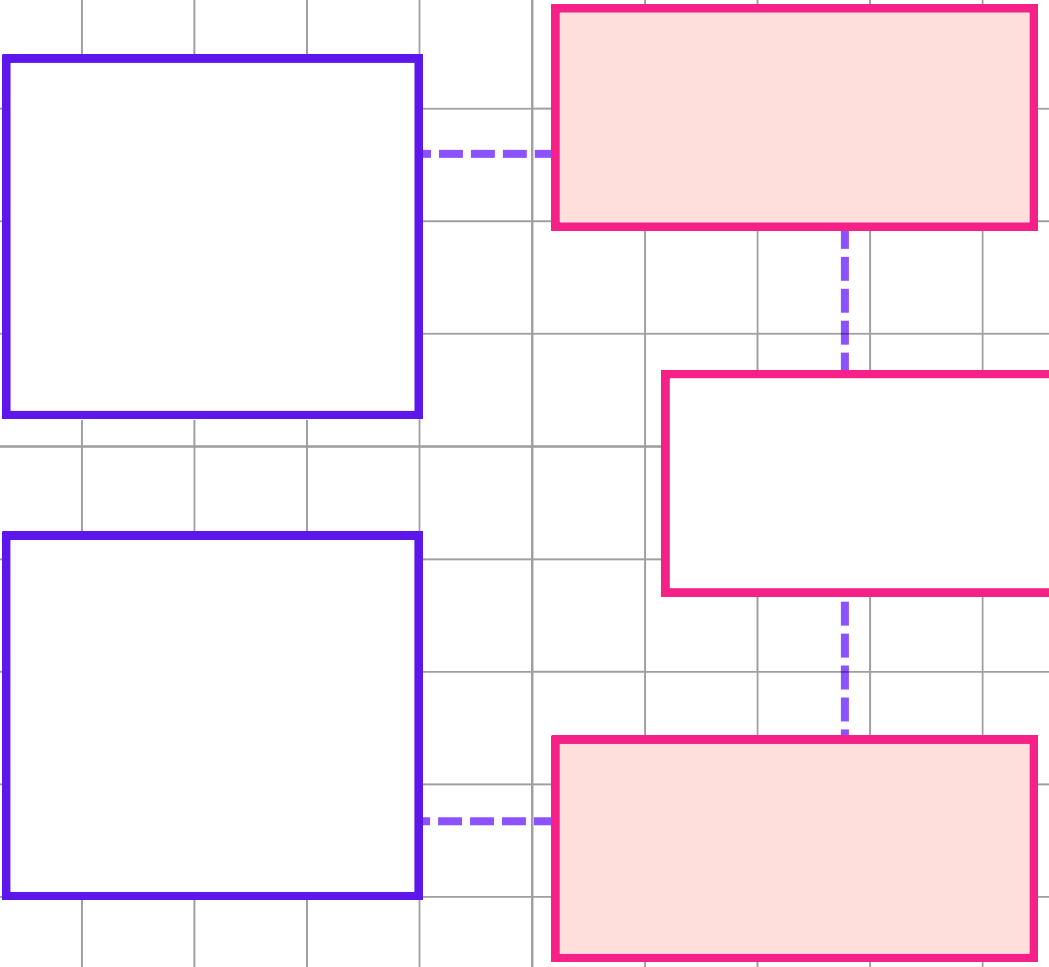
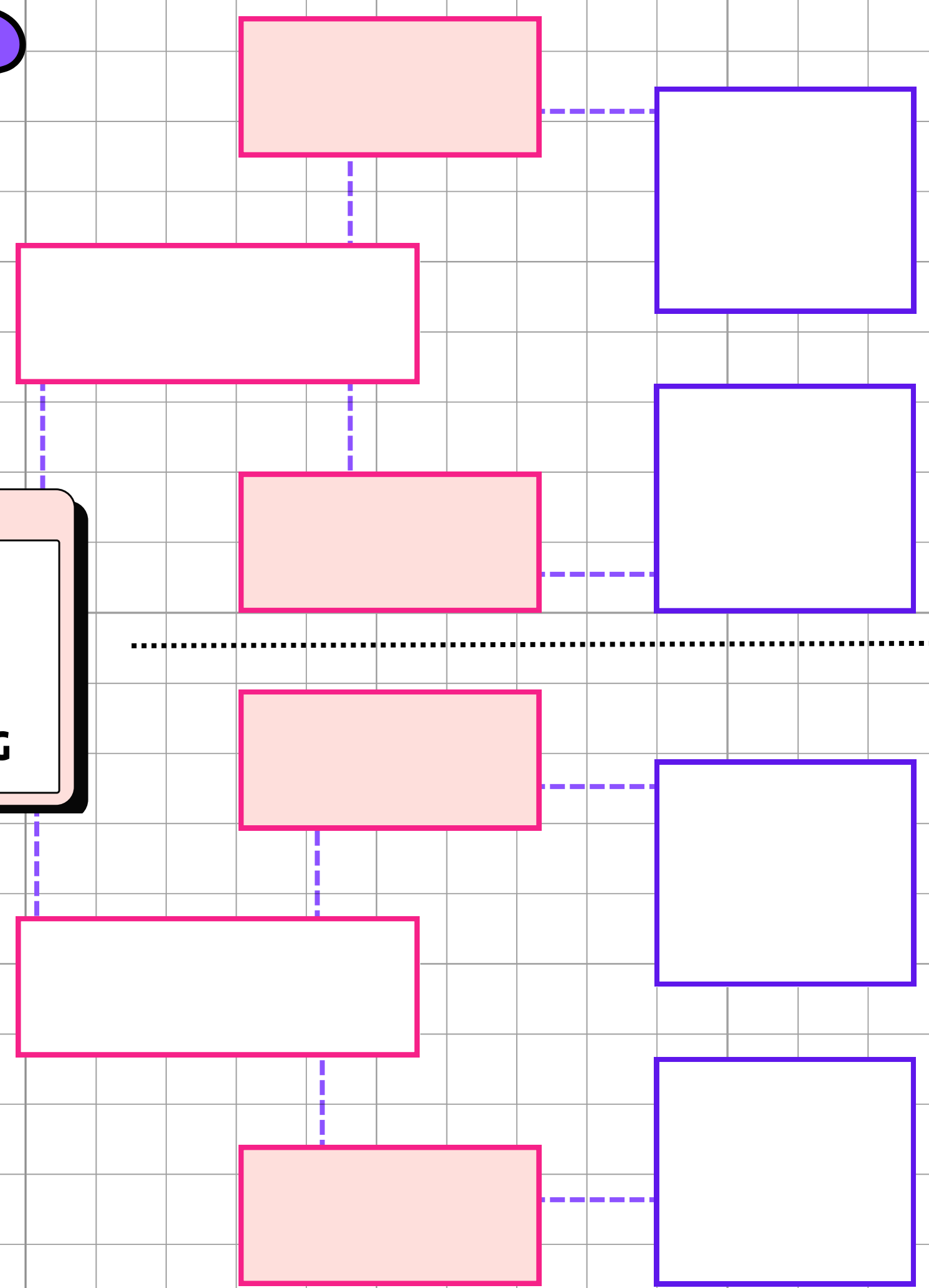
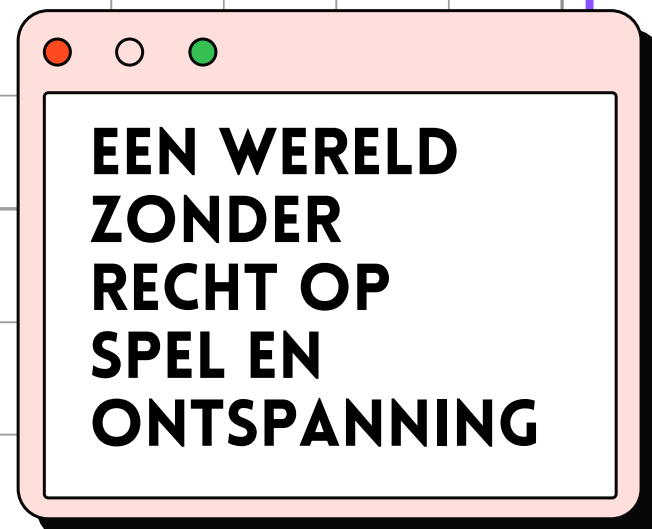
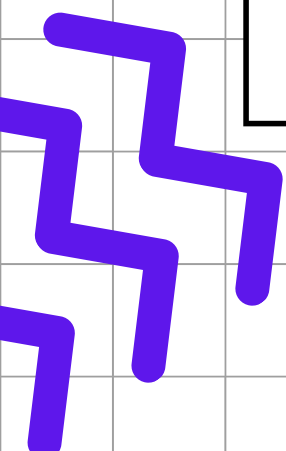
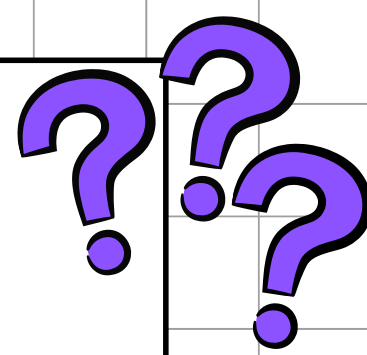

# BEELD JE IN: GEEN RECHT OP TOEGANG TOT INFORMATIE

Wat zou er gebeuren als het recht op toegang tot informatie plots verdwijnt? Geen nieuws meer. Geen regels meer of de informatie die je online vindt juist of fout is, ook niet op de nieuwskanalen.

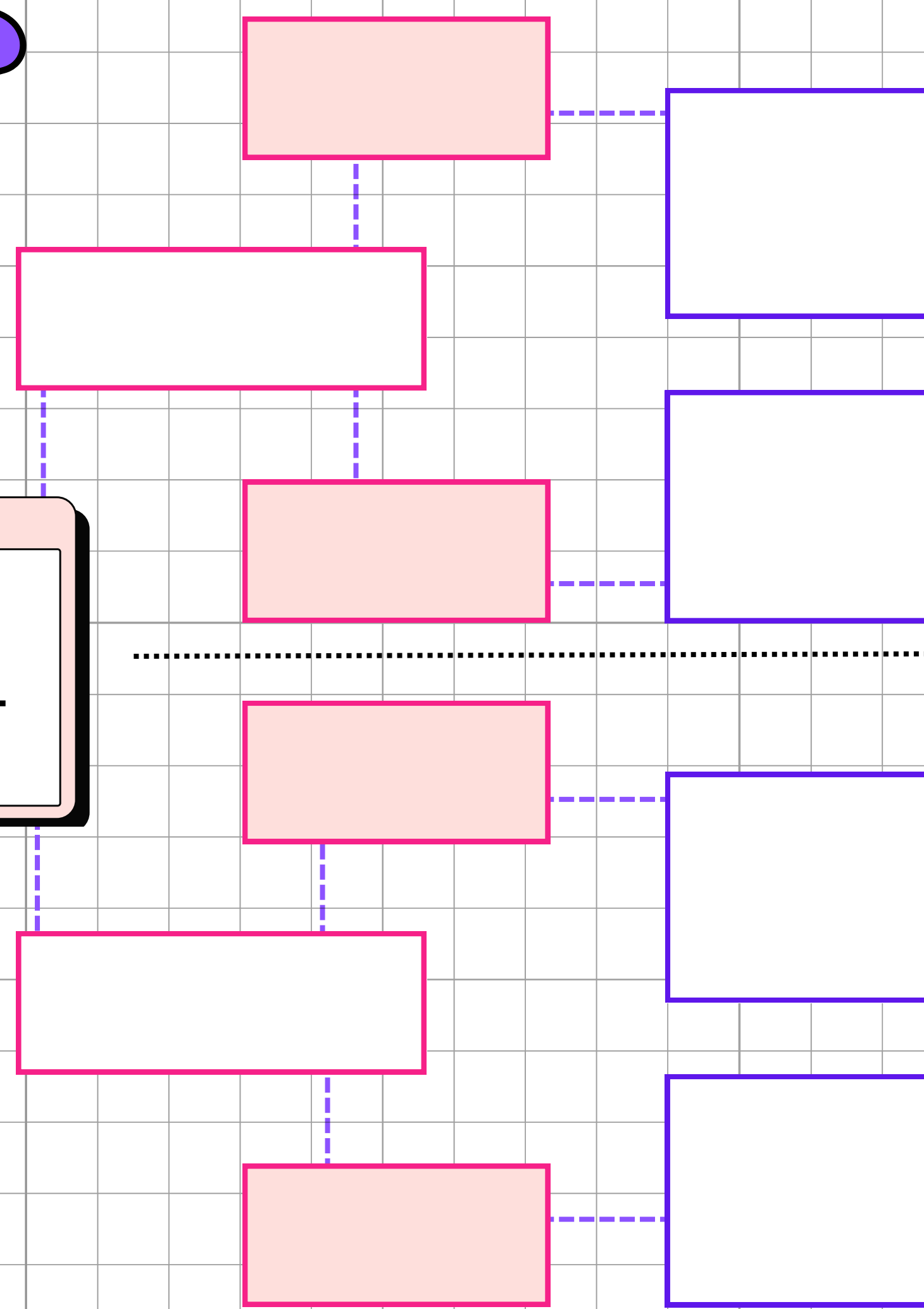
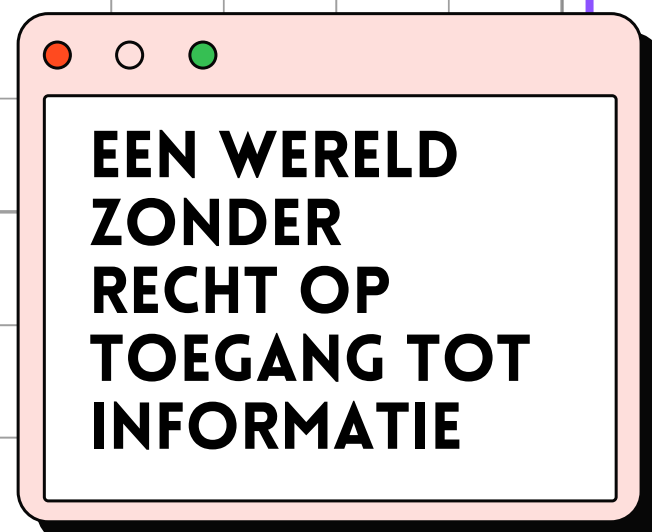
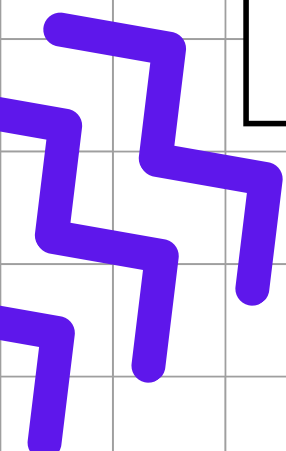
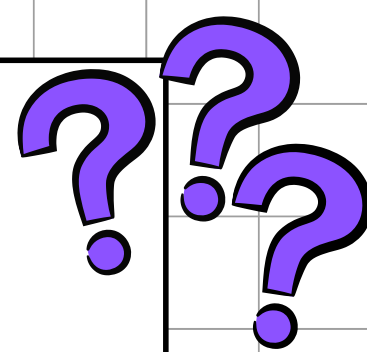

# BEELD JE IN: GEEN RECHT OP BESCHERMING TEGEN GEWELD

Wat zou er gebeuren als het recht op bescherming tegen geweld plots verdwijnt? Geen politie die je helpt als iemand je pijn doet. Geen regels over het verbieden van pesten, ook niet online of in de klas.

